

- Ⓐ Colector drenaje 1"
1" Drainage manifold
- Ⓑ Colector entrada 4"
4" Inlet manifold
- Ⓒ Colector salida 4"
4" Outlet manifold

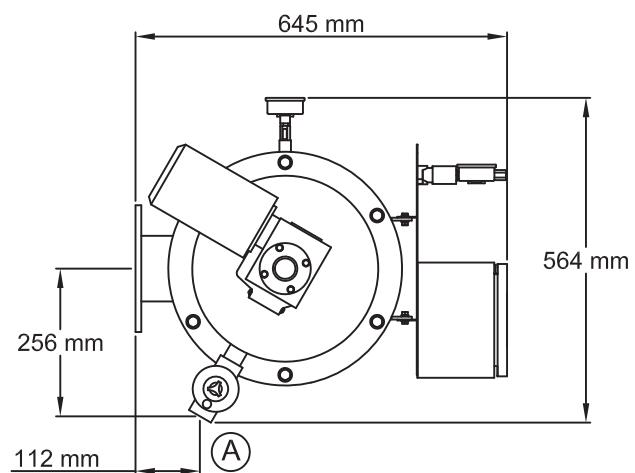

AZUD LUXON LDB 2400/4

SCALE S/E A4 FORMAT	MATERIAL:	RESPONS.: M. Martínez	AZUD
	UNITS: mm.	REVISION: 00	
	FILE: Azud_luxon_LDB_2400-4.dwg	31/05/2011	