

- (A) Colector drenaje 1"
1" Drainage manifold
- (B) Colector entrada 4"
4" Inlet manifold
- (C) Colector salida 4"
4" Outlet manifold

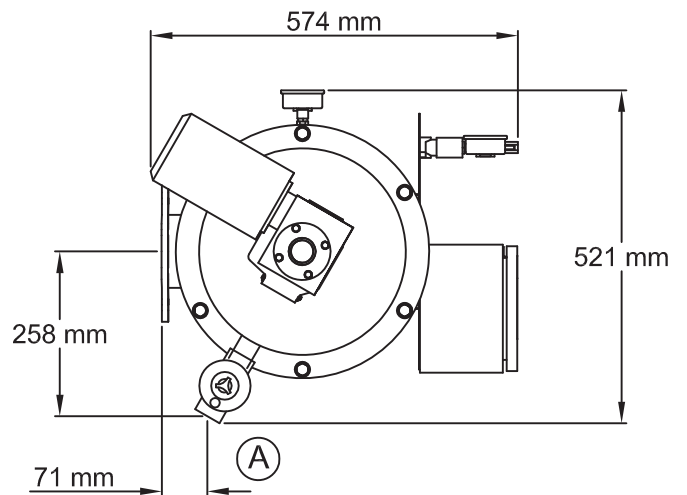

AZUD LUXON LDB 1600/4

SCALE S/E A4 FORMAT	MATERIAL:	RESPONS.: M. Martínez	AZUD
	UNITS: mm.	REVISION: 00	
	FILE: Azud_luxon_LDB_1600-4.dwg	12/04/2012	