

- Ⓐ Colector drenaje 2"  
**2" Drainage manifold**
- Ⓑ Colector entrada 14"  
**14" Inlet manifold**
- Ⓒ Colector salida 14"  
**14" Outlet manifold**

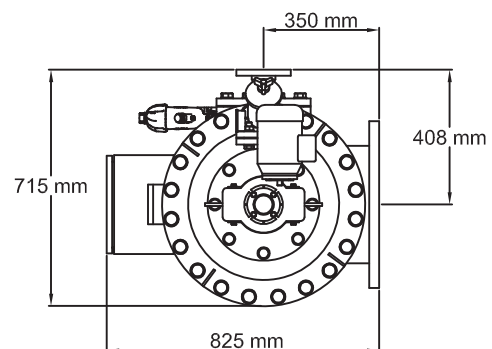

### AZUD LUXON LDB 13200 S/14

SCALE S/E A4 FORMAT	MATERIAL:	RESPONS.: M. Martínez	<b>AZUD</b>
	UNITS: mm.	REVISION: 00	
	FILE: Azud_luxon_LDB_13200-S14.dwg	07/05/2012	